

The switching of a shunt capacitor bank results in voltage and current transients which can create problems at the substation and elsewhere in the power system. The application of a pre-insertion impedance—such as a pre-insertion inductor—at the capacitor-bank switching device can control the voltage and current transients and thus mitigate these problems. This publication discusses the problems associated with capacitor bank switching and explains why S&C’s Standard-Duty and Enhanced-Duty Pre-Insertion Inductors are especially suited for solving them.

### Introduction

When energizing a shunt capacitor bank without a pre-insertion impedance, the local bus voltage abruptly changes to that of the capacitor bank, which is generally zero. The sharp collapse in voltage transmits a fast transient voltage into the system through lines and cables connected to the capacitor-bank bus. The system recovers to a new steady-state voltage with the bank on, by means of a transient which is a damped sinusoidal oscillation defined by the capacitance of the bank, the inductance of the system, and the resistance of loads and losses (including energy dispersion due to the surge impedance of lines and cables). The sinusoidal transient overshoots as it oscillates around the new steady-state voltage, creating an overvoltage. Typically, the frequency of the sinusoidal transient is in the range of 200 to 800 Hz.

In instances where there are other capacitor banks already energized (back-to-back switching), there is a pre-

liminary transient voltage as the local bus first recovers to an interim voltage defined by the redistribution of the charge on the energized banks with the switched bank. Thereafter, the system recovers from the interim voltage to the new steady-state voltage with all the capacitor banks oscillating. The frequency of the preliminary transient voltage is defined by the capacitance of the switched bank in series with the capacitance of the already-energized banks and the stray inductance between and within the banks. Since the stray inductance involved is quite low, the frequency of the preliminary transient is very high—on the order of several tens of kilohertz. The high-frequency preliminary transient voltage is associated with a very high transient (inrush) current.

### Problems Associated with Switching Shunt Capacitor Banks

**Inrush current.** Depending on the rate of change of the inrush current (which, in turn, is proportional to the product of its magnitude and frequency), stray currents and voltages can be induced in substation control circuitry and the ground mat—resulting in high step-potentials. Inrush currents during switching of single capacitor banks usually do not cause problems, because the magnitudes and frequencies are moderate (generally less than 5 kA and 1 kHz, respectively). See Figure 1. There can, however, be problems in the case of back-to-back bank switching because the magnitude and frequency of the inrush current are on the order of tens of kiloamperes and tens of kilohertz, respectively. In fact, the ability to induce stray

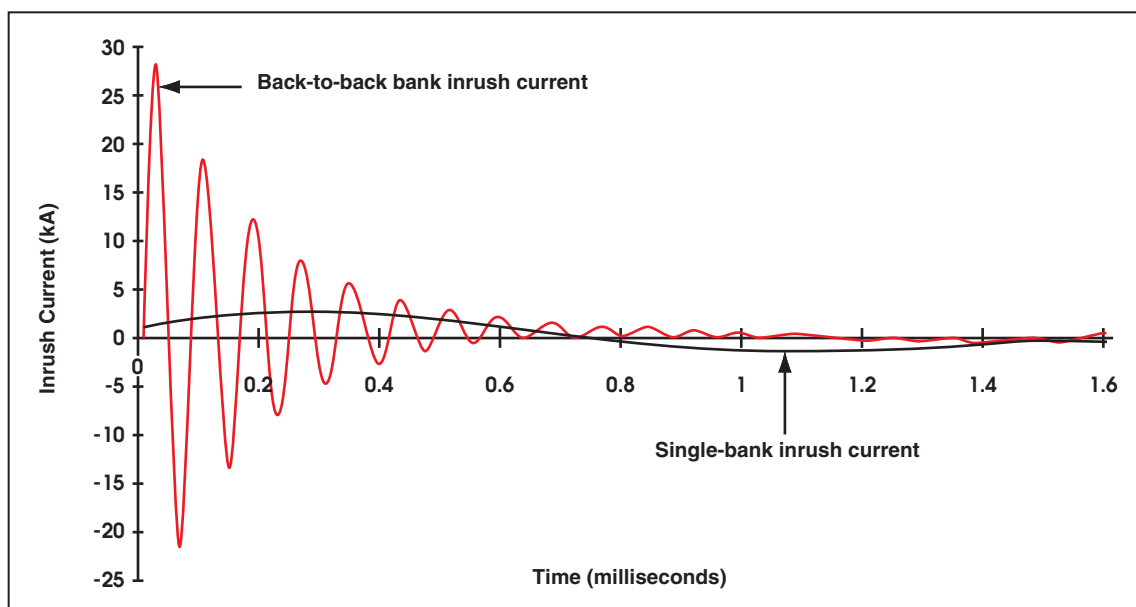

**Figure 1. Inrush current during switching of single capacitor bank and during back-to-back bank switching. (The initial step in inrush current during single bank switching is caused by transmission lines discharging into the capacitor bank.)**



currents and voltages through back-to-back bank switching can be significantly greater than that of fault currents, due to the high-magnitude, high-frequency nature of the inrush current.

**Bus overvoltage.** As the bus voltage recovers from the collapsed voltage of the capacitor bank being energized (generally zero), it will overshoot the new steady-state voltage, creating a phase-to-ground overvoltage at the capacitor bank bus which, if uncontrolled, can be on the order of 1.6 per unit (P.U.).▲ See Figure 2. This overvoltage does not generally challenge the insulating capabilities of the power system; however, it can cause nuisance tripping of sensitive electronic loads or, worse, damage these loads.

**Voltage magnification.** The use of shunt capacitor banks elsewhere in the system, including power-factor correction capacitors at utilization voltage, creates the possibility that portions of the power system will be in near-resonance with the sinusoidal transient frequency at the switched bank. There is a possibility that, through voltage magnification, the bus overvoltage will manifest itself as a large-magnitude transient in these near-resonant regions of the power system. See Figure 3. Since most capacitor banks are sized to create a voltage regulation (defined as differential capacitance voltage, or DCV, in switchgear standards) of 1% to 4%, the natural frequency of the system at each capacitor bank tends to be in the range of 200 to 800 Hz, increasing the likelihood that voltage magnification will occur. The phenomenon of voltage magnification exacerbates the problems associated with capacitor bank-switching-induced bus overvoltages.

In many instances, voltage magnification has been identified as the cause of overvoltage tripping of voltage-sensitive devices such as voltage source inverter pulse-width-modulated adjustable-speed drives (ASDs). The magnified transient can cause the overvoltage protection circuitry of an ASD to trip-off the drive, in order to protect the device's overvoltage-sensitive components in the inverter section. See Figure 4. The transient overvoltage at the ASD input causes the dc bus capacitor—which provides a low-ripple dc voltage to the inverter section of the ASD—to charge up to a higher-than-normal voltage level. If the capacitor is charged to a voltage level equal to the trip setting of the ASD, overvoltage tripping is initiated by the drive protection circuitry.

The sensitivity of an ASD to transient overvoltages is dependent upon the size of the dc bus capacitor, the presence of a dc bus choke (connected between the rectifier at the front end of the ASD and the dc bus capacitor) or an ac line choke (connected in series with the ac supply lines to the ASD input), and the overvoltage trip setting. More robust ASDs tend to have higher dc bus capacitance values (well in excess of 100  $\mu\text{F}$  per horsepower), usually include a 3% to 5% impedance ac line choke, and typically have an overvoltage trip setting closer to 1.39 P.U. (Overvoltage trip settings generally range from 1.17 P.U. to 1.39 P.U. of nominal dc bus voltage.)◆

▲ One per unit phase-to-ground voltage =  $\sqrt{2/3}$  × rated system voltage.

◆ One per unit dc bus voltage = 1.35 × rated phase-to-phase input voltage of ASD.

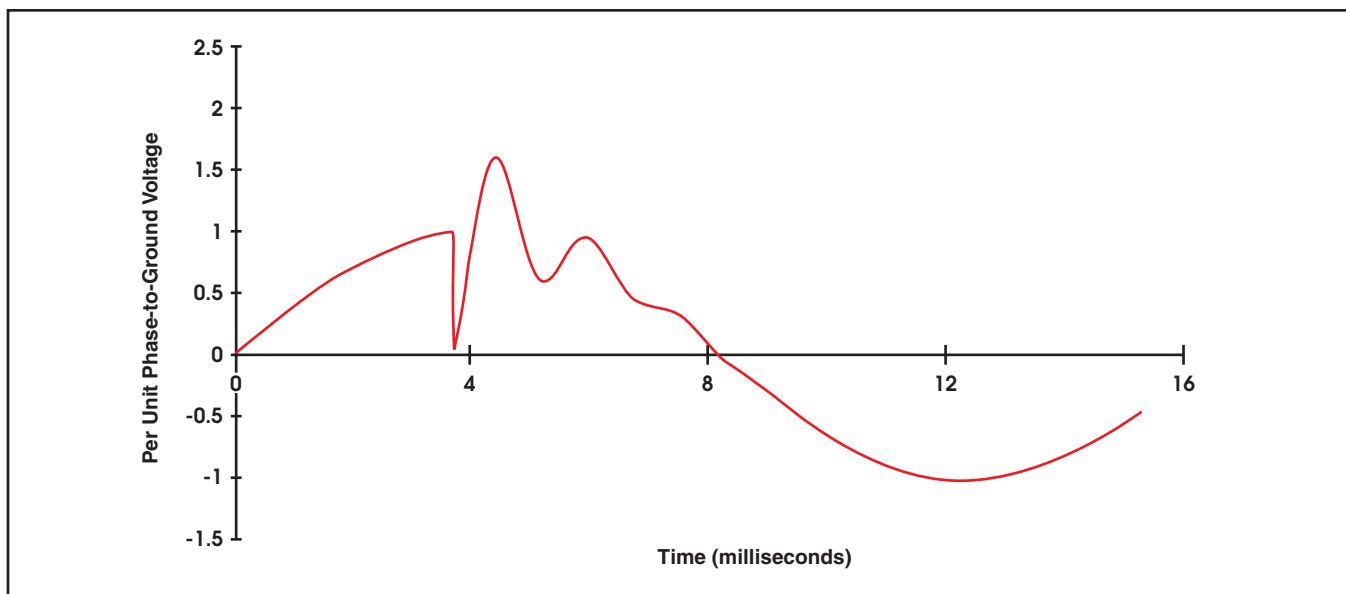

Figure 2. Overvoltage at switched capacitor bank bus.

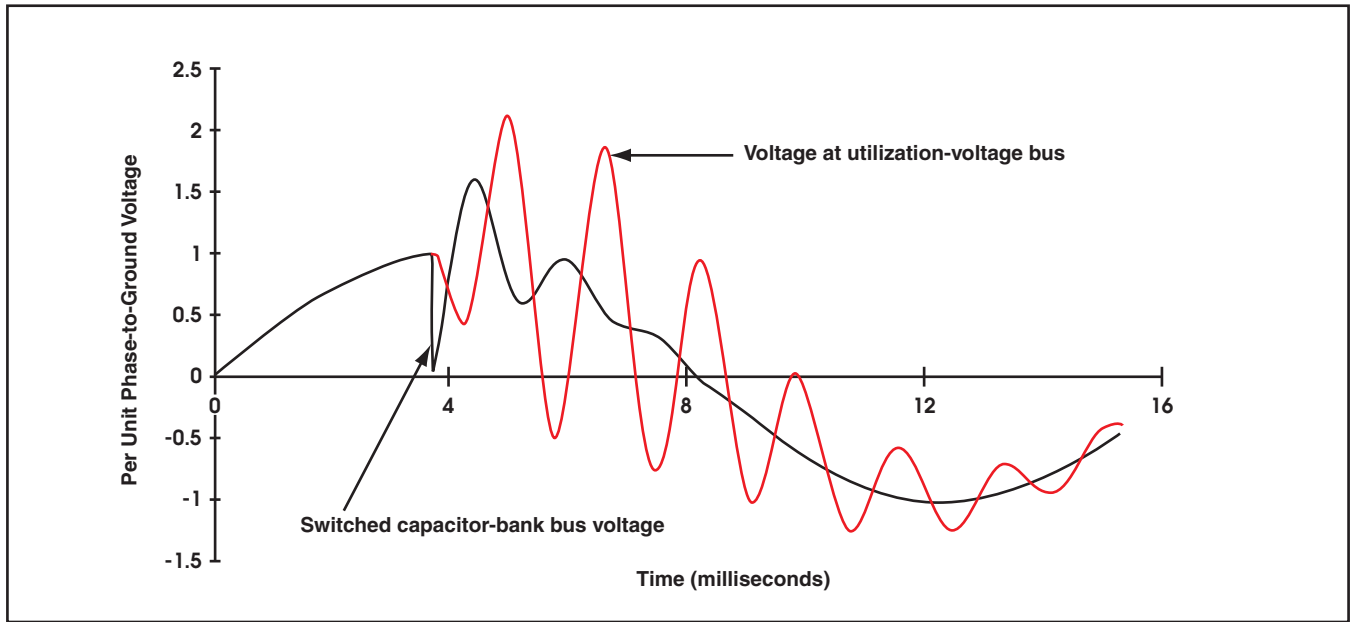

Figure 3. Voltage magnification of capacitor-switching transient at utilization-voltage bus when power-factor correction capacitors are applied.

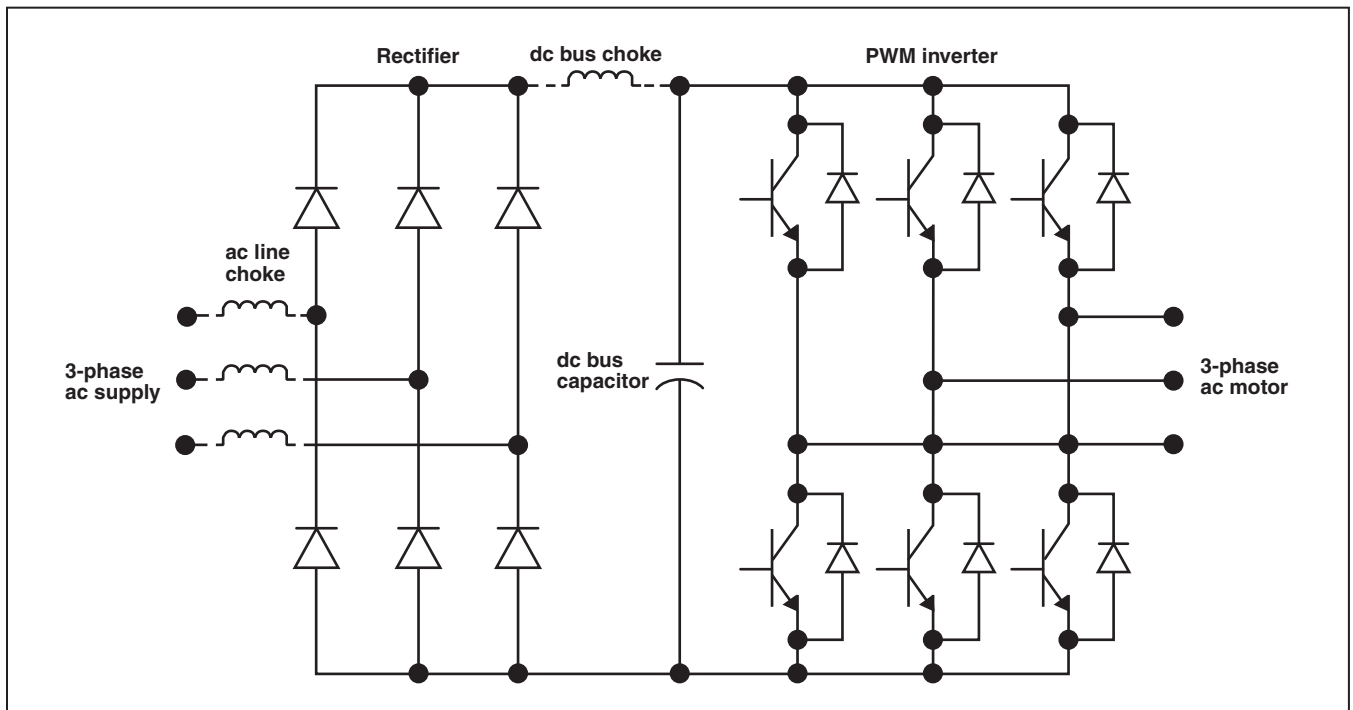

Figure 4. Major components of voltage source inverter pulse-width-modulated adjustable-speed drive.

The rise in dc bus voltage at the ASD is fundamentally determined by the amount of energy transferred to the dc bus capacitor, the extent to which this energy transfer is delayed by any inductance in series with the dc bus capacitor, and by the rate at which the transient energy is removed by the load. Consequently, the dc bus voltage level is largely determined by the magnitude and frequency of the input phase-to-phase voltages and by the size of the dc bus choke or ac line choke (if present). If the ASD is *not* equipped with any choke, the peak dc bus voltage during any transient overvoltage will be equal to the peak phase-to-phase overvoltage. If the ASD is equipped with either a dc bus choke or ac line choke, the peak dc bus voltage will be reduced.

Ac line and dc bus chokes provide improved transient overvoltage ride-through capability by delaying the charging of the dc bus capacitor while some of the transient energy is removed by the load. The dc bus choke is a standard design feature in many ASDs (typically sized for 1.8% impedance at power frequency), but is not as effective as the 3% or 5% impedance ac line chokes in mitigating transient overvoltages. Since the ASD responds to phase-to-phase voltages, the inductance values of the ac line choke in two phases appear in series with the dc bus capacitor, whereas only the single inductance value of the dc bus choke appears in series with the dc bus capacitor. Ac line chokes are generally offered as an optional feature for ASDs and are recommended where transient overvoltages may be of concern. But these chokes alone are often insufficient for preventing nuisance tripping, because magnified capacitor-switching transients can be as high as 3.1 P.U.

phase-to-ground when switching capacitor banks without a transient overvoltage control device.

**Fast transient overvoltage.** The initial collapse in voltage during capacitor bank energization is quite abrupt, leading to a very high rate-of-change in voltage. The high rate-of-change in voltage can cause significant overvoltages on the end turns of transformer windings, due to stress concentrations arising from the transient voltage being capacitively distributed across each of the primary and secondary windings (rather than being magnetically distributed). The fast transient can also be capacitively coupled through a transformer, increasing the relative magnitude of the transient on the secondary side compared to that produced through the normal transformer turns ratio. See Figure 5. Per Even et al<sup>■</sup>, the high-frequency transformer ratio can be on the order of 10:4. In a transformer where the normal ratio is 10:1 (e.g., a 138-kV to 13.8-kV transformer), a 1-P.U. phase-to-ground fast transient on the primary side can be coupled as a 4-P.U. voltage change on the secondary side. Some electronic components, such as the input diodes of uninterruptable power supplies and ASDs not furnished with ac line chokes, can be damaged by these coupled high-magnitude fast transients. Cable and shunt capacitors on the secondary side of the transformer as well as any connected load will greatly reduce the effective high-frequency ratio, mitigating the problem. The actual coupled overvoltage, therefore, is very much system dependent.

■ A. Even, A. Robert, M. Couvrer—Effects of High Voltage Capacitor Banks on MV/LV Distribution Systems, CIREN, 1987.

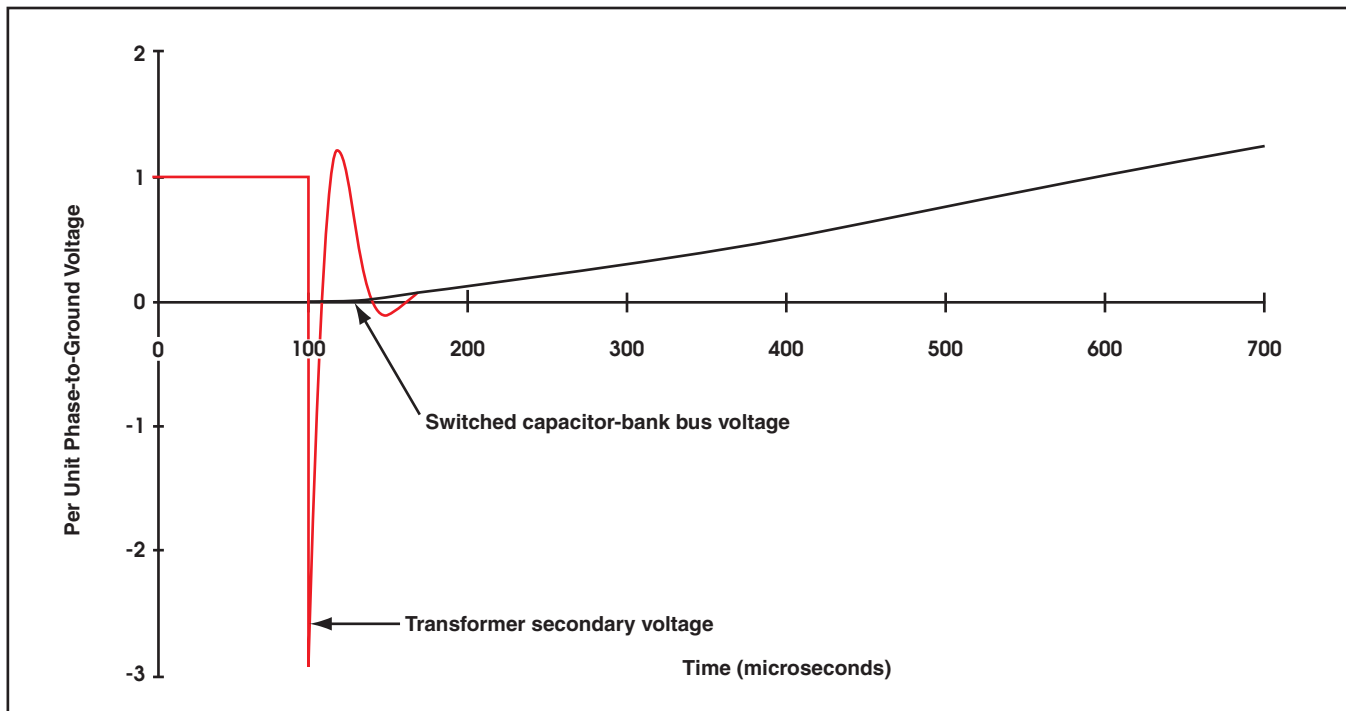

Figure 5. Fast transient overvoltage produced during energization of large-sized capacitor bank, coupled through a transformer.

**Overvoltage at radially fed transformers and open lines.** Failures of radially fed transformers have been traced to capacitor bank switching. ★ The sharp collapse in bus voltage upon energization transmits a fast transient voltage along each line connected to the capacitor-bank bus. The leakage impedance of a radially fed transformer initially acts like an open circuit to an incoming fast transient voltage and, due to the traveling-wave phenomenon, will double the wave as it is reflected back toward the capacitor-bank bus. The capacitor bank acts like a short-circuit to steep front waves, and will reflect them in a negative sense. The fast transient voltage can be reflected between the radially fed transformer and capacitor bank many times before it is finally damped out. The sinusoidal transient frequency of the capacitor-bank bus voltage and the length of the line feeding the transformer can be related such that a reflected wave will arrive at the transformer near the peak of the sinusoidal transient overvoltage, thus adding to the overvoltage. See Figure 6. The phase-to-phase overvoltage at the transformer can exceed 3.3 P.U. ■ Apparatus such as transformers and shunt reactors can experience stress concentrations at the ends of their windings due to the fast transient being distributed by the stray capacitance of the windings, instead of the linear distribution forced by the magnetic circuit.

### Pre-insertion Impedances

A pre-insertion impedance furnishes an impedance at the initial energization (insertion) of a capacitor bank, which controls the current and voltage transients. The impedance is shorted out (bypassed) shortly after the initial insertion transient damps out. The pre-insertion impedance, therefore, splits the transient associated with bank energization into two distinct components: the insertion and the bypass. The insertion transient typically lasts for about one cycle of the power frequency, after which the pre-insertion impedance has a power-frequency voltage across it, from the power-frequency bank current. The power-frequency voltage is a function not only of the pre-insertion impedance but also of the bank size, with larger-sized banks producing larger voltages.

★ R. S. Bayless, J. D. Selman, D. E. Truax, W. E. Reid—Capacitor Switching and Transformer Transients, IEEE Transactions on Power Delivery, pp. 349-357, January, 1988.

● R. P. O'Leary, R. H. Harner—Evaluation of Methods for Controlling the Overvoltages Produced by the Energization of Shunt Capacitor Banks, CIGRE 13-05, 1988.

■ One per unit phase-to-ground voltage =  $\sqrt{2/3} \times 3$  rated system voltage.

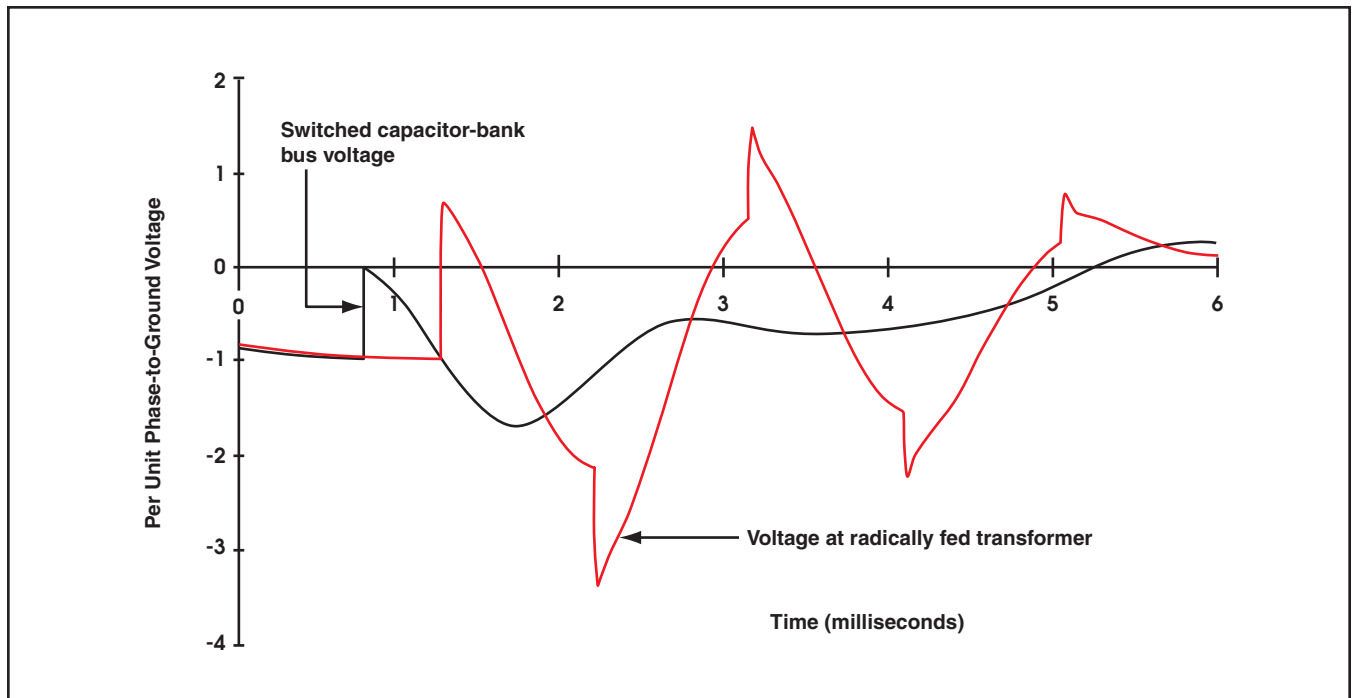

Figure 6. Overvoltage at remote radially fed transformer when switching capacitor bank, resulting from traveling-wave phenomenon.

At bypass, the voltage across the pre-insertion impedance drives a reduced-magnitude oscillatory transient, the characteristic of which is no longer influenced by the pre-insertion impedance, since it is shorted out. The characteristic of the bypass transient is exactly that of an uncontrolled-closing energization transient, except that its magnitude is greatly reduced since the driving voltage is a fraction of the full voltage available to drive the uncontrolled-closing transient.

The ultimate performance of a pre-insertion impedance must be evaluated considering both the insertion and bypass transients. In general, a higher pre-insertion impedance is more effective for controlling the insertion transient, but will drive a larger bypass transient due to the higher power-frequency voltage across it (especially in the case of larger-sized banks, which draw higher currents). The optimum pre-insertion impedance balances the insertion transient against the bypass transient.

### Standard-Duty Pre-insertion Inductor

The S&C Standard-Duty Pre-Insertion Inductor has an ideal frequency response for use as a pre-insertion impedance. At the higher frequency of the insertion transient, its reactive impedance is relatively high, suppressing inrush current and limiting bus voltage collapse. At 60 Hz, its reactive impedance is much lower, which produces a lower bypass voltage. The bypass voltage across the standard-duty pre-insertion inductor is typically in the range of 0.01 P.U. to 0.09 P.U. of phase-to-ground voltage, thus producing minimal transients at bypass.

The following table summarizes the nominal inductance and resistance values of standard-duty pre-insertion inductor offerings.

STANDARD-DUTY PRE-INSERTION INDUCTORS			
For Capacitor Bank		Circuit-Switcher Catalog Number Suffix	Inductor Description
System Voltage Rating, kV, Nom.	Size, MVAC		
34.5	3 to 33	-P5	10 millihenry, 2.4 ohm
46	4 to 44		
69	5 to 65▲	-P5	10 millihenry, 2.4 ohm
		-P51	40 millihenry, 5.5 ohm
115	10 to 84	-P5	40 millihenry, 5.5 ohm
138	13 to 81		
230	17 to 198		(2) 10 millihenry, 2.4 ohm

▲ Catalog Number Suffix “-P5” pre-insertion inductors generally limit, to 2 per unit, phase-to-ground overvoltages on unloaded open-ended lines up to 30 miles from 5- to 20-MVAC capacitor banks, up to 50 miles from 21- to 65-MVAC capacitor banks. For effectiveness up to 50 miles from 5- to 20-MVAC capacitor banks, specify Catalog Number Suffix “-P51.”

Because of its inductive nature, the standard-duty pre-insertion inductor reduces the rate-of-change in bus voltage at insertion by a factor of about 100. But because the standard-duty pre-insertion inductor has relatively little resistance, other losses in the system must be relied upon for damping transients. Where voltage magnification is of concern, extra damping is sometimes desirable.

### Enhanced-Duty Pre-insertion Inductor

The S&C Enhanced-Duty Pre-Insertion Inductor features a significant internal resistance to enhance damping of insertion transients. The damping of the enhanced-duty pre-insertion inductor has been optimized to render superb control of capacitor bank overvoltages such that, even when a system is predisposed to voltage magnification, nuisance tripping of sensitive equipment such as ASDs equipped with 3% impedance ac line chokes is not a problem. The inductive portion of the impedance offers the same benefits of the standard-duty pre-insertion inductor. But because of the non-frequency-dependent response of its internal resistance, the impedance at 60 Hz is limited to that of the resistance. The bypass transient is therefore increased over that generated by the standard-duty pre-insertion inductor. The bypass voltage across the enhanced-duty pre-insertion inductor is typically on the order of 0.05 P.U. of phase-to-ground voltage for smaller-sized banks and up to 0.35 P.U. of phase-to-ground voltage for medium- to large-sized banks.

The following table summarizes the nominal inductance and resistance values of enhanced-duty pre-insertion inductor offerings.

ENHANCED-DUTY PRE-INSERTION INDUCTORS			
For Capacitor Bank		Circuit-Switcher Catalog Number Suffix	Inductor Description
System Voltage Rating, kV, Nom.	Size, MVAC		
34.5	3 to 11	-P6	18 millihenry, 39 ohm
	12 to 22	-P61	10.6 millihenry, 17 ohm
46	4 to 18	-P6	18 millihenry, 39 ohm
	19 to 36	-P61	10.6 millihenry, 17 ohm
69	5 to 20	-P6	40 millihenry, 81 ohm
	21 to 42	-P61	18 millihenry, 39 ohm
115	10 to 60	-P6	40 millihenry, 81 ohm
138	13 to 75		

## How S&C Pre-insertion Inductors Solve Problems Associated with Switching Shunt Capacitor Banks . . .

### Inrush Current

**Using standard-duty pre-insertion inductors.** During insertion, the significant impedance of the standard-duty pre-insertion inductor reduces the magnitude of the inrush current associated with back-to-back bank switching to less than 3.5 kA. See Figure 7. The inductance also lowers the frequency of the preliminary transient to the range of several hundred hertz. The combination of reduced magnitude and frequency is extremely effective in reducing inrush currents which can induce stray currents and voltages in substation control circuitry and the ground mat. Because of the very low bypass voltage across the standard-duty pre-insertion inductor, inrush currents at bypass are only 1% to 9% of those experienced with no pre-insertion impedance.

**Using enhanced-duty pre-insertion inductors.** Performance of the enhanced-duty pre-insertion inductor during insertion is somewhat better than that of the standard-duty pre-insertion inductor due to the typically larger induc-

tance and resistance of the former. However, inrush currents at bypass can be 5% to 35% of those experienced with no pre-insertion impedance for some medium- and large-sized capacitor banks. The 65% reduction in inrush current is significant, but some attention to the station ground mat and to the routing of control cables may be needed to obtain good performance.

### Bus Overvoltage and Voltage Magnification

**Using standard-duty pre-insertion inductors.** The standard-duty pre-insertion inductor will typically limit phase-to-ground overvoltages at the capacitor-bank bus to 1.3 P.U. to 1.5 P.U. The degree of control offered by the standard-duty pre-insertion inductor is generally acceptable for all loads which conform to the Information Technology Industry Council's (ITIC's) typical design goals of power-conscious computer manufacturers (IEEE Standard 446). In some cases, however, voltage-sensitive equipment such as less-robust ASDs may trip-off from phase-to-ground overvoltages lower than 1.5 P.U. at the capacitor-bank bus. The likelihood of affecting ASDs is further increased by voltage magnification.

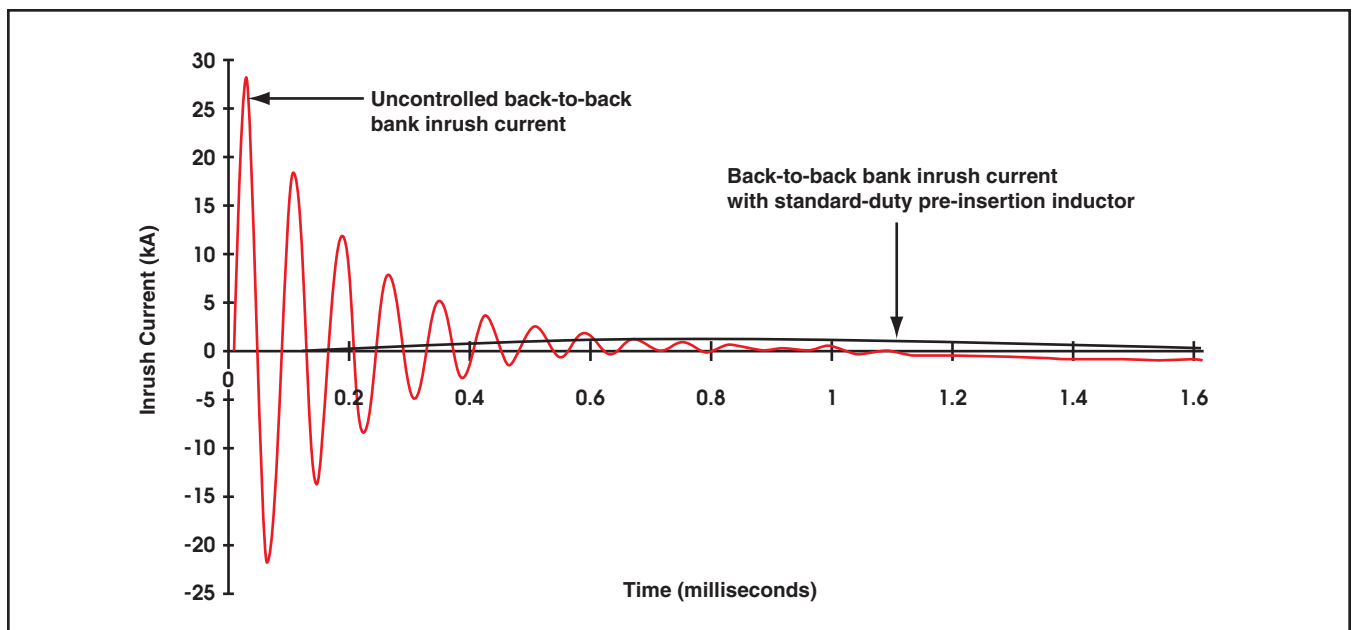

Figure 7. Reduction in magnitude and frequency of inrush current when switching back-to-back capacitor banks with standard-duty pre-insertion inductors.

**Using enhanced-duty pre-insertion inductors.** The inherent damping provided by the enhanced-duty pre-insertion inductor, along with system losses, generally limit the phase-to-ground overvoltage at the capacitor-bank bus to 1.1 P.U. to 1.2 P.U., except in the case of very large-sized banks, wherein the overvoltage is limited to less than 1.3 P.U. This reduction in overvoltage at the capacitor-bank bus also results in a significantly reduced overvoltage at the utilization-voltage bus when voltage magnification occurs. See Figure 8. In the absence of voltage magnification, the damping of the transient will generally prevent nuisance tripping of ASDs—even in instances where the ASD is not equipped with a 3% impedance ac line choke. But with voltage magnification, the enhanced-duty pre-insertion inductor will still prevent nuisance tripping of ASDs, provided that they are equipped with 3% impedance ac line chokes.

### **Fast Transient Overvoltage**

Both the standard-duty pre-insertion inductor and enhanced-duty pre-insertion inductor will greatly reduce the rate-of-change in voltage at insertion, completely eliminating the fast transient problem. The enhanced-duty pre-insertion inductor, when applied on larger-sized banks, will produce a fast transient during bypass which is less than 0.35 P.U. of that experienced with no pre-insertion impedance, and will typically couple to the secondary side of the transformer at less than 1.6 P.U. of phase-to-ground voltage. The standard-duty pre-insertion inductor will produce a fast transient which is less than 0.1 P.U. of that experienced with no pre-insertion impedance, and will typically couple to the secondary side of the transformer at less than 0.4 P.U. See Figure 9.



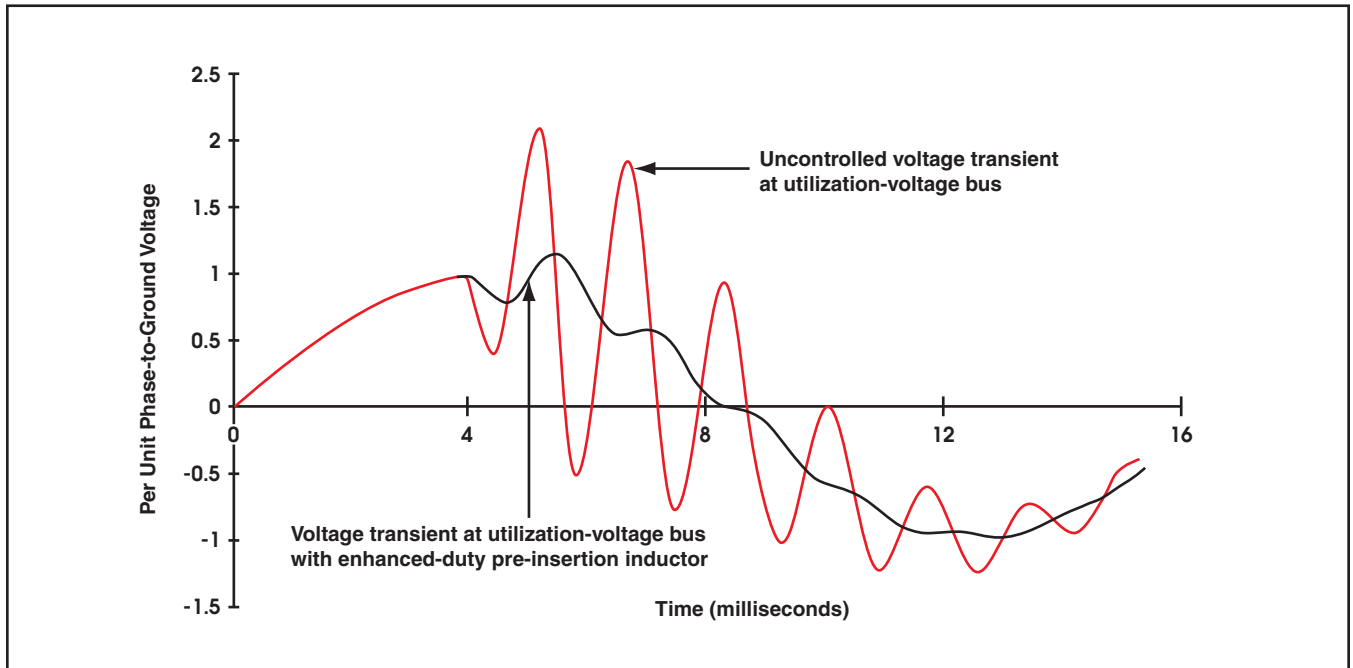

Figure 8. Reduction in voltage magnification at utilization-voltage bus when switching capacitor bank with enhanced-duty pre-insertion inductors.

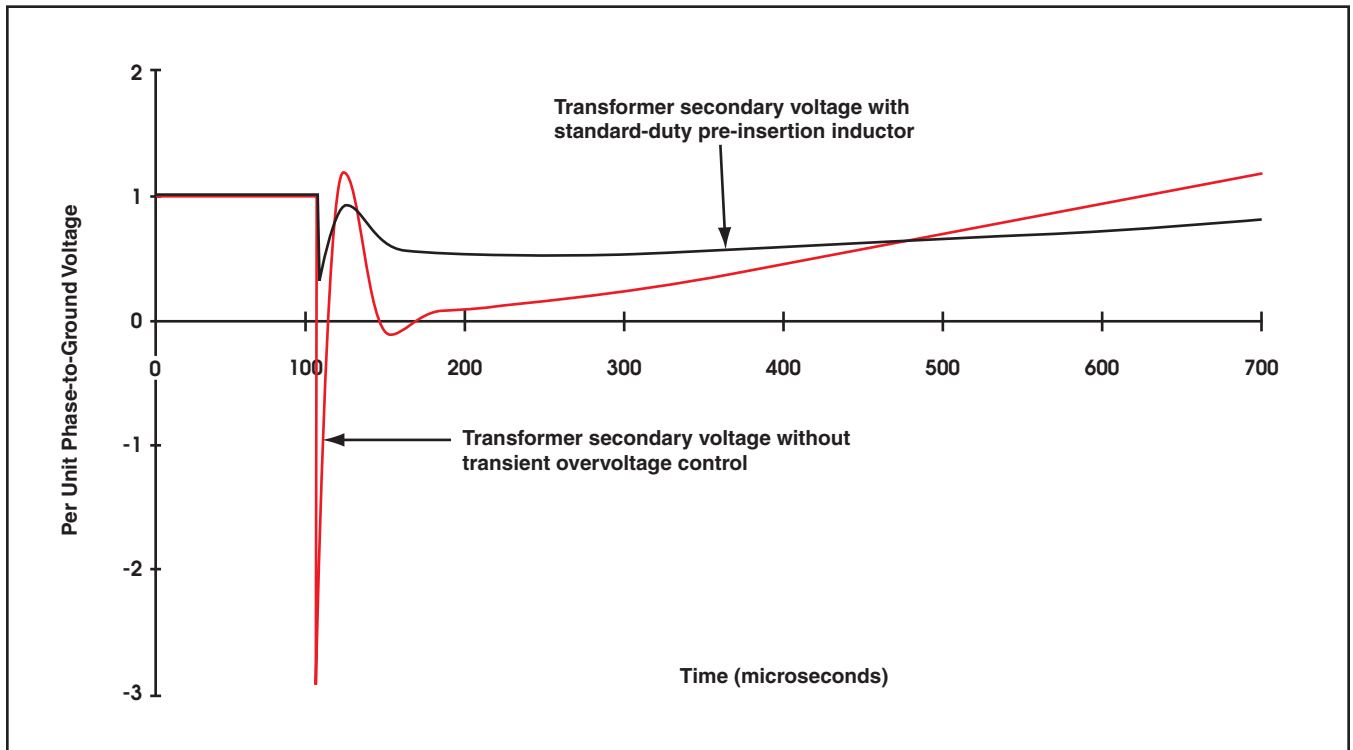

Figure 9. Reduction in fast transient overvoltage coupled through a transformer when switching large-sized capacitor bank with standard-duty pre-insertion inductors. (The transients with and without overvoltage control ultimately damp out to the same voltage.)

### Overvoltage at Radially-Fed Transformers and Open Lines

Both the standard-duty pre-insertion inductor and the enhanced-duty pre-insertion inductor will effectively control radially-fed transformer and end-of-line overvoltages. See Figure 10. The enhanced-duty pre-insertion inductor, when applied on large-sized banks, will produce a higher overvoltage at bypass than the standard-duty pre-insertion inductor, but this overvoltage will generally not exceed 2.0 P.U. of phase-to-ground voltage at the end of an open line.

### Application Recommendations

The following table summarizes the problems associated with switching of shunt capacitor banks and indicates the effectiveness of standard-duty and enhanced-duty pre-insertion inductors for solving those problems.

APPLICATION RECOMMENDATIONS		
Problem	Effectiveness of Standard-Duty Pre-insertion Inductor	Effectiveness of Enhanced-Duty Pre-insertion Inductor
Inrush current on back-to-back bank switching	Excellent	Good▲
Overvoltage at capacitor bank bus	Excellent	Excellent
Overvoltage at utilization voltage bus—without voltage	Excellent	Excellent
Overvoltage at utilization voltage bus—with voltage magnification	Not recommended	Excellent
Fast transient overvoltage	Excellent	Excellent◆
Overvoltage at radially-fed transformers and open lines	Excellent	Excellent◆

- ▲ Inrush currents are reduced to between 5% and 35% of the uncontrolled transient in back-to-back bank switching applications.
- ◆ Effectiveness of enhanced-duty pre-insertion inductors is reduced for the largest-sized capacitor banks for which these inductors are offered.

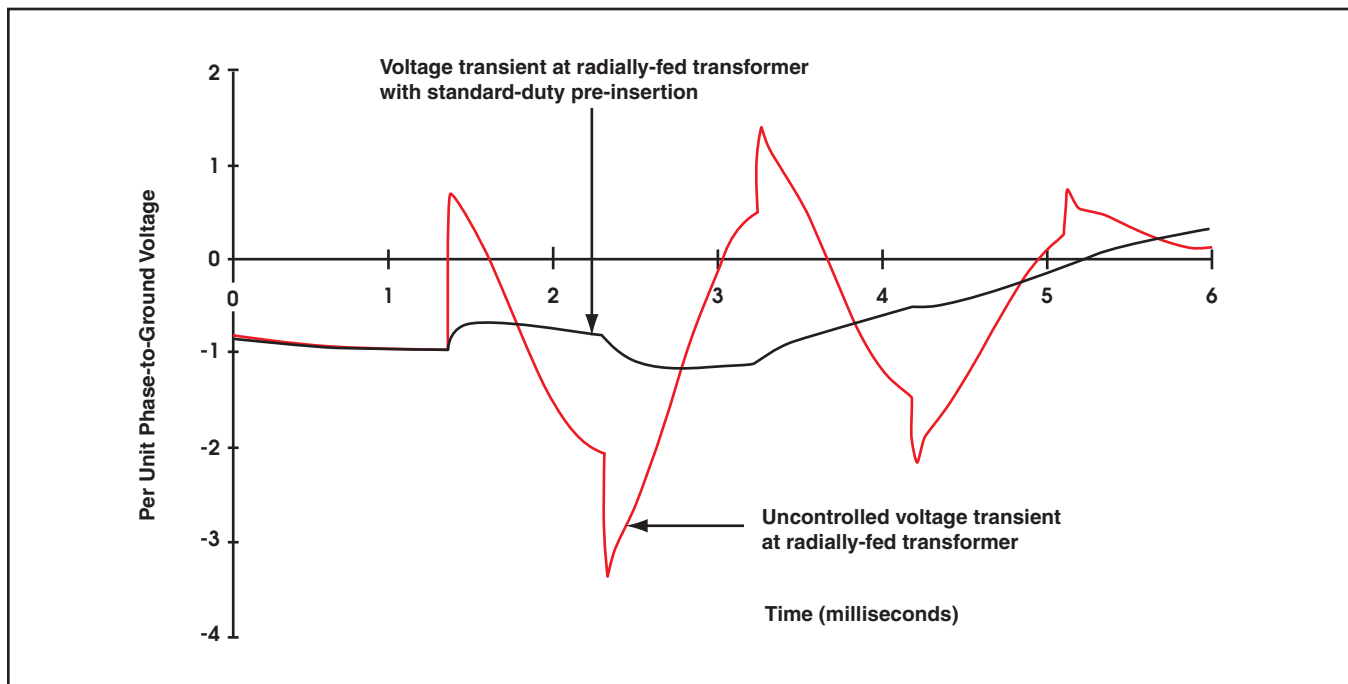

Figure 10. Reduction in overvoltage at remote radially-fed transformer when switching capacitor bank with standard-duty pre-insertion inductors.



